

KENSINGTON.

Desktop**MicroSaver**[®]

Installation Instructions

Mode d'emploi

Installationsanweisungen

Hoe installeer ik de MicroSaver

Istruzioni per l'installazione

Instrucciones de instalación



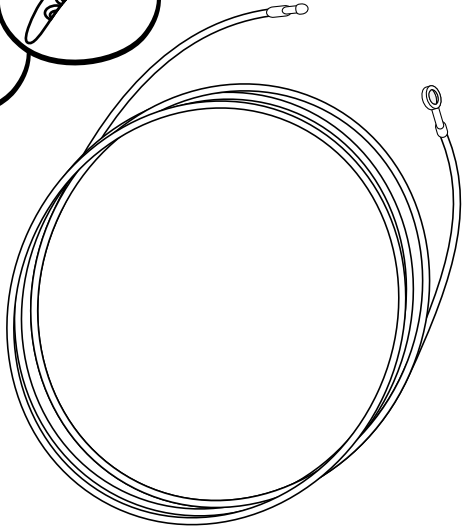
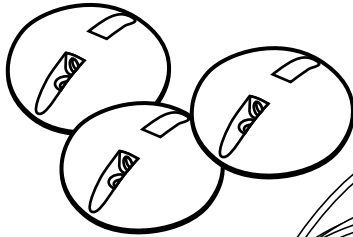

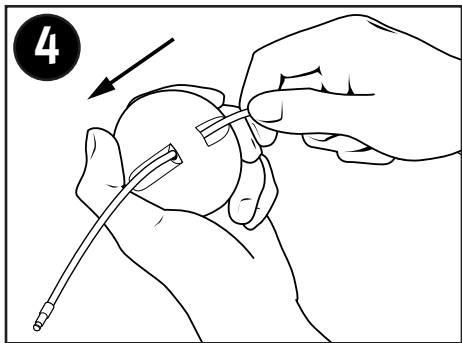
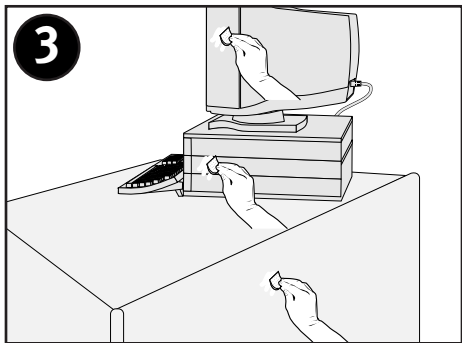
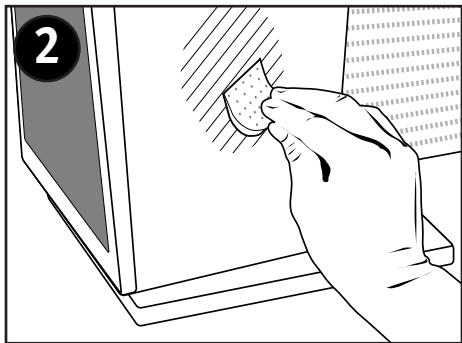
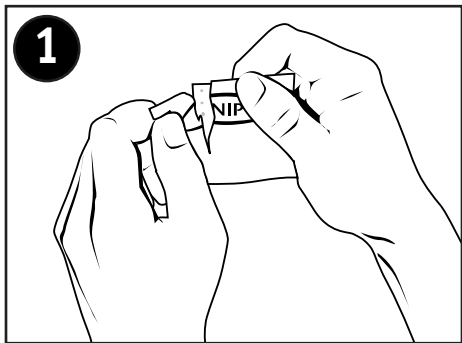

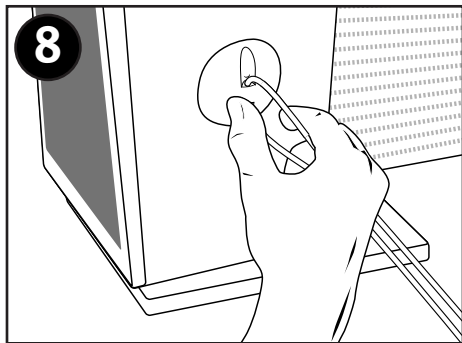
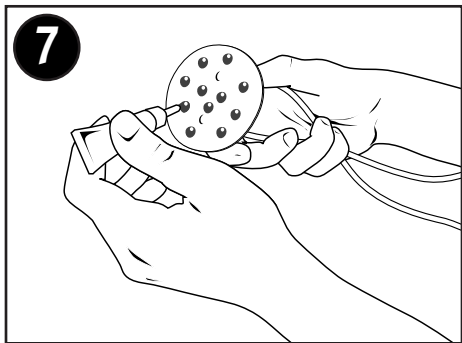
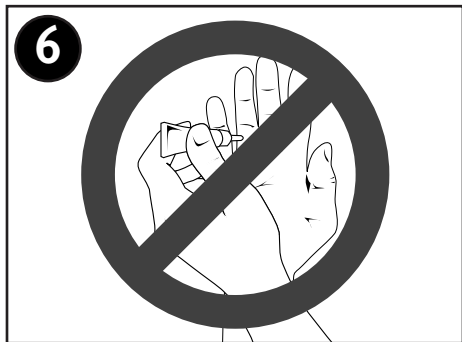
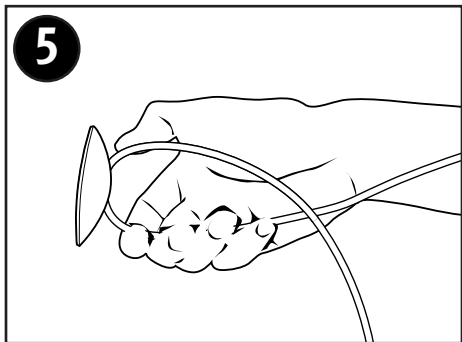

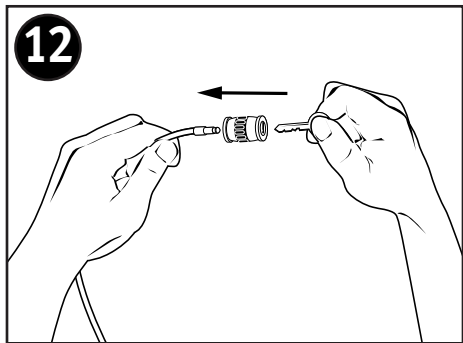
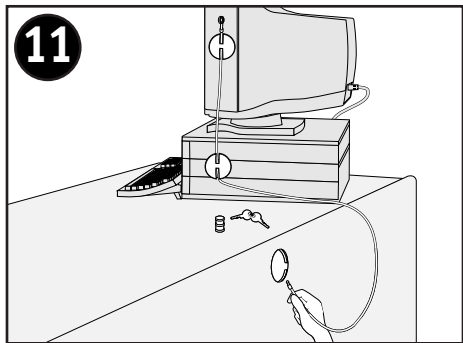
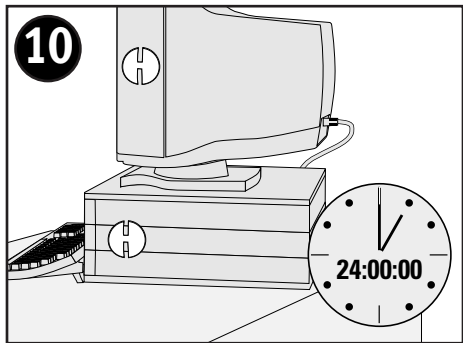
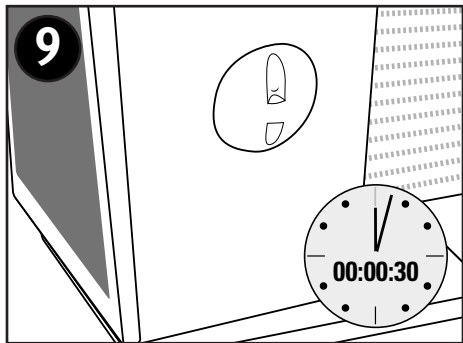

13

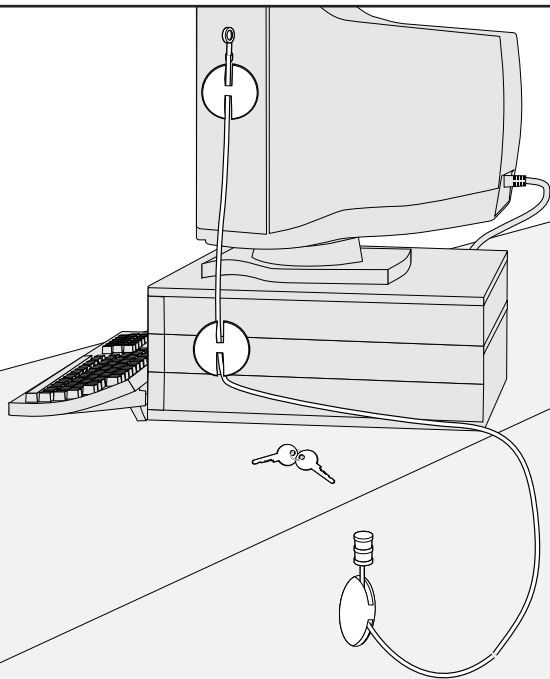

ENGLISH

Important! Be sure to register your key code online at www.kensington.com. Your key code is stamped into the metal face of your key. If you are unable to register online, copy the key code and store it in a safe place. You will need to have the code to order a replacement key from Kensington Technical Support.

FRANÇAIS

Important ! Enregistrez votre code de clé personnelle par Internet au site www.kensington.com. Votre code de clé est imprimé sur la face métallique de votre clé. Si vous ne pouvez pas enregistrer par Internet, veuillez conserver cette carte en lieu sûr. Si vous perdez votre clé, ce code sera indispensable pour recevoir une clé de rechange.

DEUTSCH

Wichtig! Sie sollten Ihren Schlüsselcode online auf unserer Website (www.kensington.com) registrieren. Der Schlüsselcode ist in die metallene Vorderseite des Schlüssels eingegrät. Wenn keine Online-Registrierung möglich ist, kopieren Sie den Schlüsselcode, und bewahren Sie ihn sicher auf. Sie benötigen den Code, falls Sie einen Ersatzschlüssel bestellen müssen.

NEDERLANDS

Belangrijk! Gelieve uw sleutelcode on-line te registreren via www.kensington.com. Uw sleutelcode is in het metalen oppervlak van uw sleutel gestanst. Als u niet on-line kunt registreren, schrijf de code den over en bewaar die op een veilige plaats. U hebt de code nodig voor het geval u een vervangende sleutel moet bestellen.

ITALIANO

Importante! Registrare il codice della chiave in linea all'indirizzo www.kensington.com. Se non è possibile registrare il codice in linea, copiarlo e conservarlo al sicuro. Per ordinare una chiave di ricambio è necessario questo codice.

ESPAÑOL

¡Importante! Asegúrese de registrar su código de llave electrónicamente en www.kensington.com. Su código de llave está impreso en la cara metálica de su llave. Si no puede registrarla electrónicamente, copie el código de llave y almacénelo en un lugar seguro. Usted necesitará tener el código en caso de que necesite ordenar una llave de repuesto.

Satisfaction Guaranteed. This product comes with a lifetime warranty and free technical support.

Satisfaction garantie. Ce produit est garanti à vie et vous donne droit à une assistance technique gratuite.

Wir garantieren Ihnen vollste Zufriedenheit. Dieses Produkt erhalten Sie mit lebenslanger Garantie und kostenloser technischer Unterstützung.

Gegarandeerd tevreden. Dit product wordt geleverd met een levenslange garantie en gratis technische ondersteuning per telefoon.

Soddisfazione garantita! Questo prodotto è coperto da garanzia a vita e da assistenza tecnica gratuita.

Satisfacción garantizada. Este producto incluye una garantía ilimitada y servicio de soporte técnico gratuito.

Technical Support

Austria	0800-295791	Mexico	610-266-0560
Belgium	0800-16778	Netherlands	0800-0222-694
Canada	610-266-0560	Norway	800-11335
Denmark	800-17838	Spain	900-993129
Finland	9800-13228	Sweden	020-795845
France	0800-906053	Switzerland	800-558605
Germany	0800-1810654	United Kingdom	0800-894383
Ireland	1-800-552180	United States	610-266-0560

Kensington Technology Group ACCO Brands, Inc.

2000 Alameda de las Pulgas
Second Floor
San Mateo, CA 94403
USA

ACCO Canada, Inc.
5 Precidio Court
Brampton, Ontario L6S 6B7
Canada

ACCO Europe PLC
Nepicar House, London Road
Wrotham Heath, Sevenoaks
Kent, TN15 7RS, United Kingdom

Assembled in USA • Réuni aux
Etats-Unis • Zusammengebaut in
USA • Bijeen ter USA • Montato
in S.U.A. • Ensamblado en los

Kensington and MicroSaver are registered trademarks of ACCO World Corporation. All other registered and unregistered trademarks are the property of their respective owners.

US Patent No. 5,327,752, 5,502,989 and 5,381,685. Other US and foreign patents pending.

© 2001 Kensington Technology Group, a division of ACCO Brands, Inc. 07/01. All rights reserved.

Limited Lifetime Warranty

Kensington Technology Group, a division of ACCO Brands, Inc. (Kensington) warrants this product against defects in material and workmanship for the life of the product as follows:

Kensington will supply, at its option, comparable new and rebuilt replacements for defective parts and will pay the labor charges to repair the product found to be defective. Should Kensington be unable to replace or repair the product, Kensington will reimburse you for your original purchase price providing you can submit the dated bill of sale as evidence of the original purchase price along with the defective product.

To obtain warranty service during the warranty period, call one of the numbers listed below.

In order to keep this warranty in effect, the purchaser must have handled and used the product as prescribed in the instructions accompanying this Warranty. This Warranty does not cover any damage due to accident, misuse, abuse or negligence. This Warranty is valid only if the product is used on the computer or system specified on the product box. Please check product box for details or call technical support.

Repair or replacement as provided under this warranty is the exclusive remedy of the consumer. In no event shall Kensington be liable for any incidental or consequential damages. This warranty is in lieu of all other warranties, expressed or implied, including implied warranties of merchantability or fitness for a particular purpose.

Some states or countries do not allow the exclusion or limitation of incidental or consequential damages, so the above limitation or exclusion may not apply to you. Some states or countries do not allow limitations on how long an implied warranty lasts, so the above limitation may not apply to you. This warranty gives you specific legal rights, and you may also have other rights which vary from state to state.

Kensington et MicroSaver sont des marques déposées de ACCO World Corporation. Toutes les autres marques de commerce, déposées ou non, sont la propriété de leurs titulaires respectifs.

Brevet Numéro 5.327.752, 5.502.989 et 5.381.685 Des USA. D'autres USA et brevets en instance étrangers.

© 2001 Kensington Technology Group, une division de ACCO Brands, Inc. 07/01. Tous droits réservés.